

ATACAMA 3

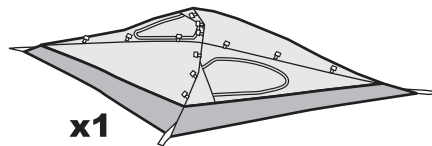

FERRINO

ISTRUZIONI DI MONTAGGIO • ASSEMBLY INSTRUCTIONS • INSTRUCTIONS DE MONTAGE • INSTRUCCIONES DE MONTAJE

A x2

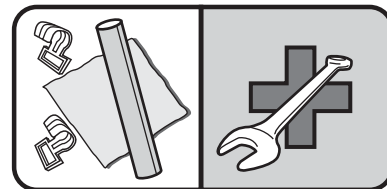
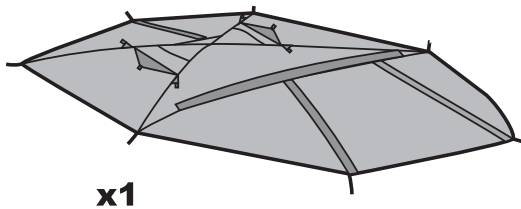

B x1



1

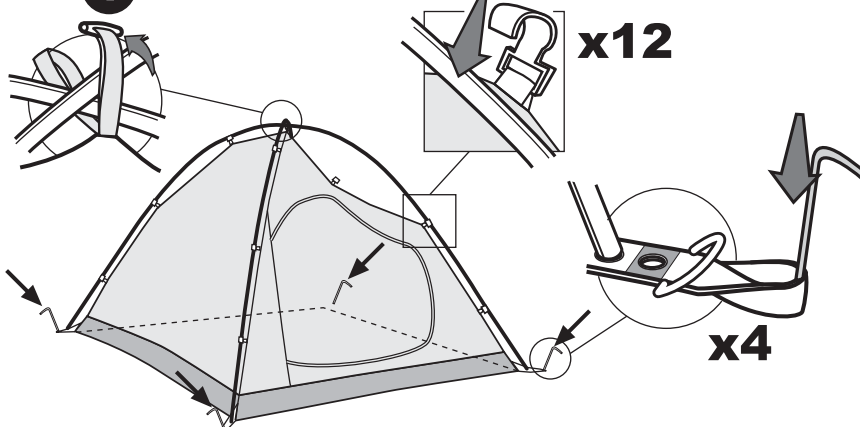
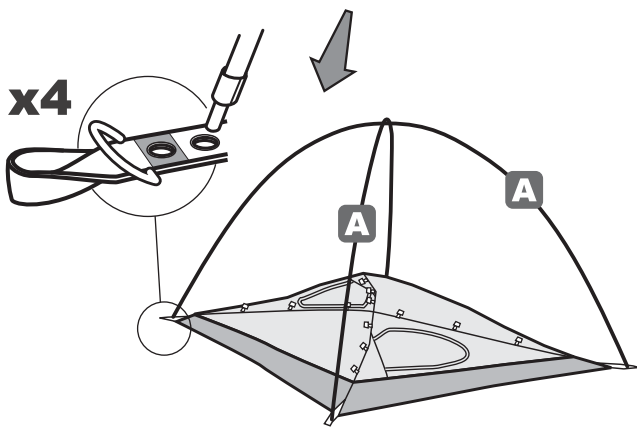

2

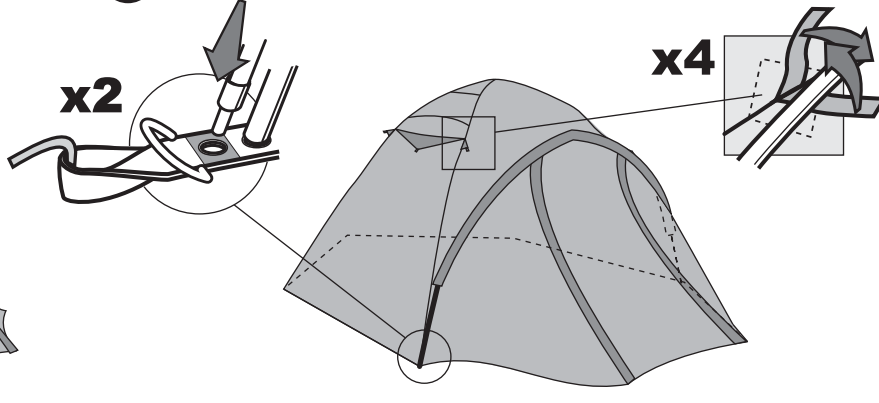
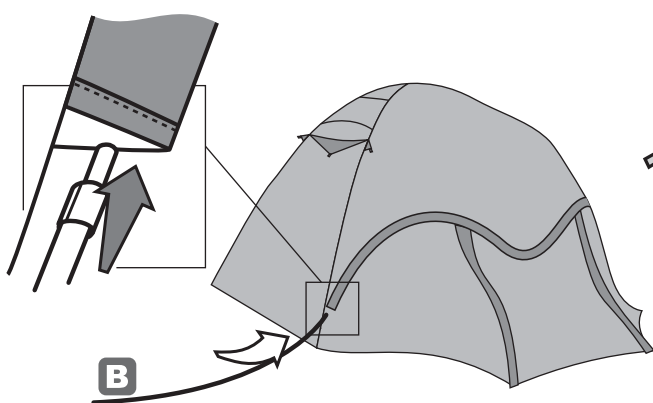

3

